

Embedded Audio Player Module TDS055 MP3 Module

I .Features

- >Power supply DC 5V to DC 9V
- >Dimension 50mm*30mm
- >Support mp3 audio format
- >Stereo audio output with good sound quality
- >Memory type SD card (32Mb to 2Gb)
- >SD card File System FAT32
- >For simple application,
- > Means of communication : Serial port RS232 (TTL)
- >9600bit/s 1 start bit+ 8 data bit+1 end bit None verify (TTL level)
- >Play mp3 files in “SONG” folder in SD card once give module power .
- >External MCU control volume and play exact files in the “ADVERT” folders.

II .Product picture

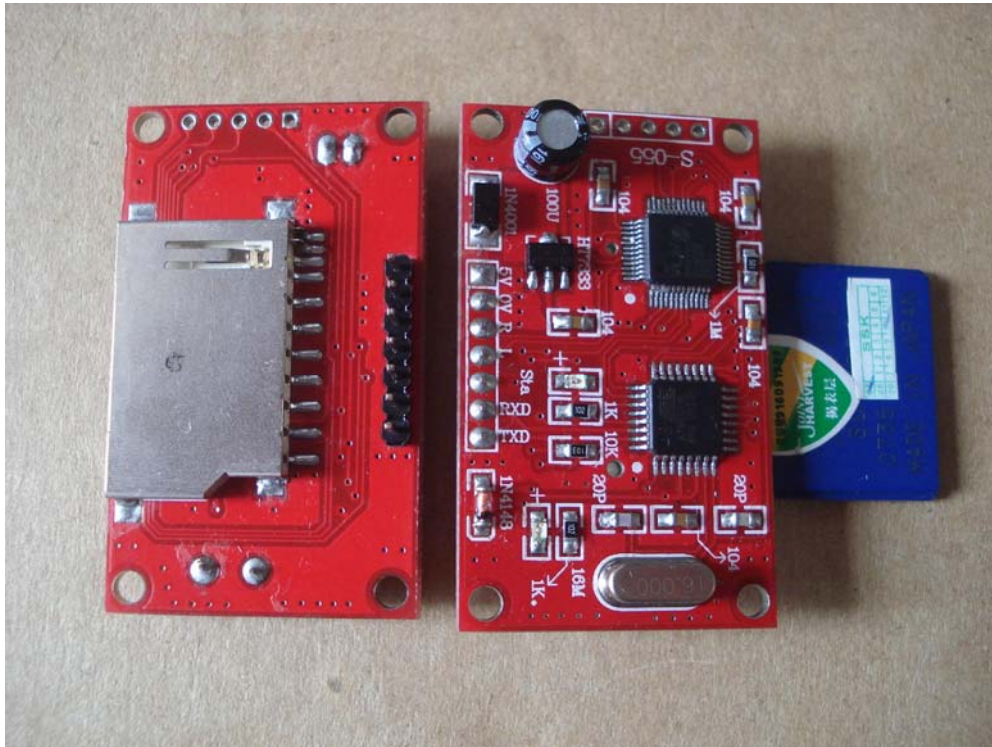

III.Applications

- a. Public place announcement system
- b. Entertainment device sound sources
- c. Tourism guide device
- d. High class gift and toys.
- e. Announcer, alarm, advertising, background music systems
- f. Selfservice audio navigation system in dining room, hotel, bank...
- g. And other products need high quality and long duration sound.

IV.Pins descriptions

Pins	Descriptions
5V	Power positive DC5V to DC9V
0V	GND
R	R audio output
L	L audio output
Sta	Playing indicator (Low level normally , when playing it is High Level)
RXD	Serial interface receive pin (TTL level)
TXD	Serial interface transmit pin(TTL level)

V.Communication format

Item	Function	Byte A	Byte B	Byte C	Byte D	Byte E	Byte F	Byte G
1	Play song	02H	A0H	-	-	-	-	-
2	Pause song	02H	A1H	-	-	-	-	-
3	Stop song	02H	A2H	-	-	-	-	-
4	Next song	02H	A3H	-	-	-	-	-
5	Previous song	02H	A4H	-	-	-	-	-
6	Volume control	03H	A5H	Volume(0-8)	-	-	-	-
7	Play ad.	07H	A6H	Folder name tens	Folder name digits	File name digits	File name tens	File name hundreds
8	Pause ad.	02H	A7H	-	-	-	-	-
9	Continue ad.	02H	A8H	-	-	-	-	-
10	Stop ad.	02H	A9H	-	-	-	-	-

1.Play song (02H/A0H)

Note: In pause or stop state ,send these codes will make it into playing state ..

Byte A: 02H

Byte B :A0H

Receive:

Receive correctly and return: 'ok'

2. Pause song (02H/A1H)

Note: In playing state, send these codes will make it into pause state.

Byte A: 02H

Byte B :A1H

Receive:

Receive correctly and return: 'ok'

3. Stop song (02H/A2H)

Note: In playing state, send these codes will make it into stop state.

Byte A: 02H

Byte B :A2H

Receive:

Receive correctly and return: 'ok'

4. Stop song (02H/A3H)

Note: In playing ,pause or stop state, send these codes will make it into next song.

Byte A: 02H

Byte B :A3H

Receive:

Receive correctly and return: 'ok'

5. Stop song (02H/A4H)

Note: In playing ,pause or stop state, send these codes will make it into previous song.

Byte A: 02H

Byte B :A4H

Receive:

Receive correctly and return: 'ok'

6. Volume control (02H/A5H)

Note: For volume adjustment

Byte A: 03H

Byte B :A5H

Byte C: Volume level (0 – 8)

Receive:

Receive correctly and return: 'ok'

7.Play ad(07H/A6H/)

Note: Play advertisement

Byte A: 07H

Byte B:A6H

Byte C:Folder name tens (ASCII value)

Byte D:Folder name digits(ASCII value)

Byte E: File name hundreds (ASCII value)

Byte F: File name tens(ASCII value)

Byte G : File name digits (ASCII value)

Receive correctly and return: 'ok'

8.Pause ad (02H/A7H)

Note:In advertisement playing state, send these codes to pause the it .

Byte A: 02H

Byte B: A7H

Receive correctly and return: 'ok'

9.Pause ad (02H/A7H)

Note:In advertisement pause state, send these codes to continue it .

Byte A: 02H

Byte B: A8H

Receive correctly and return: 'ok'

10.Stop ad (02H/A9H)

Note:In advertisement pause state, send these codes to continue it .

Byte A: 02H
 Byte B: A9H
 Receive correctly and return: 'ok'

VI. RS232 Serial Interface Test

1. Set up a Max232 circuit as follow schematic

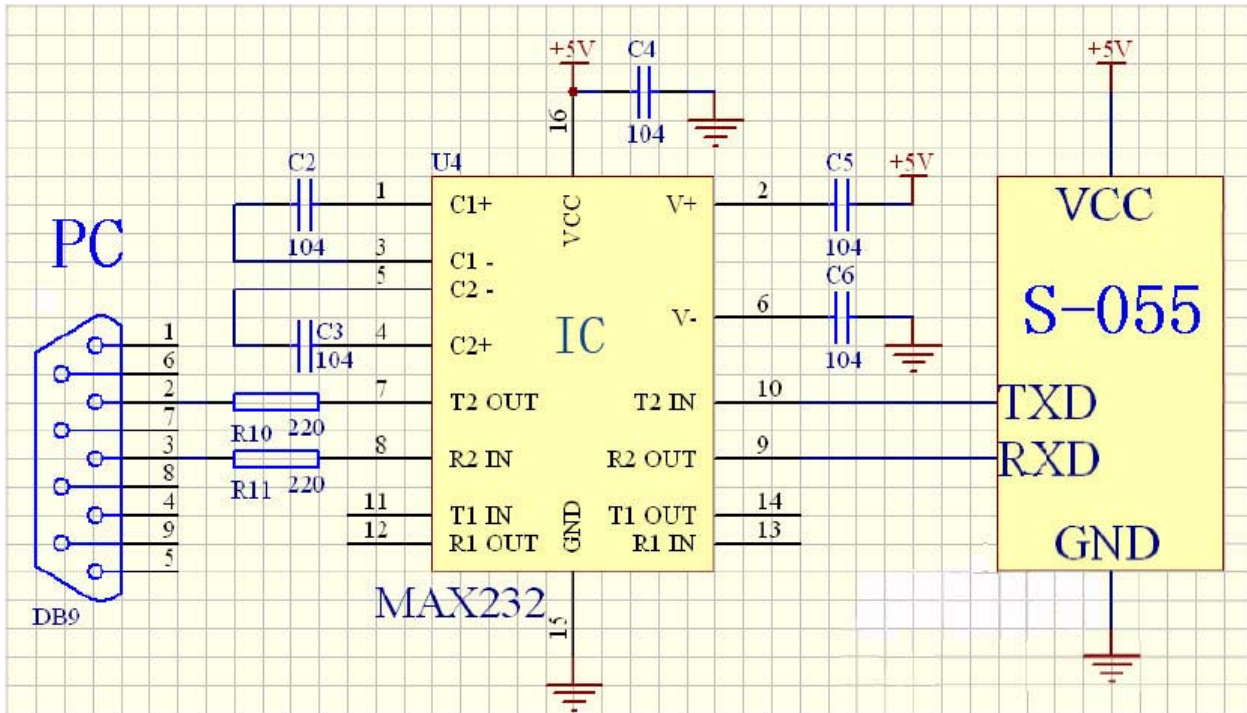

2. Format the SD card to "FAT32" ,then new "SONG" folder and ADVERT folders.
 ADVERT folders' name should b ADVERT01,ADVERT02,ADVERT03,.....ADVERT99 , 99 folders maximum.
 And mp3 files in each ADVERT folder should be 001.mp3 ,002.mp3,003.mp3999.mp3 ,
 999 mp3 files in each folder maximum.

Folders in SD card



MP3 files in SONG folder



big big world.mp3



my love.mp3



seasons in the sun.mp3



say you say me.mp3



yesterday once more.mp3



love .mp3



my heart will go on .mp3



take me to your heart .mp3

MP3 files in ADVERT folders



001. mp3



002. mp3



003. mp3



004. mp3



005. mp3



006. mp3



007 . mp3



008 . mp3

3. Connect computer to Max232 circuit and module , open the SSCOM 3.2 or other serial interface assistant software download from Internet

Click “Send Hex”

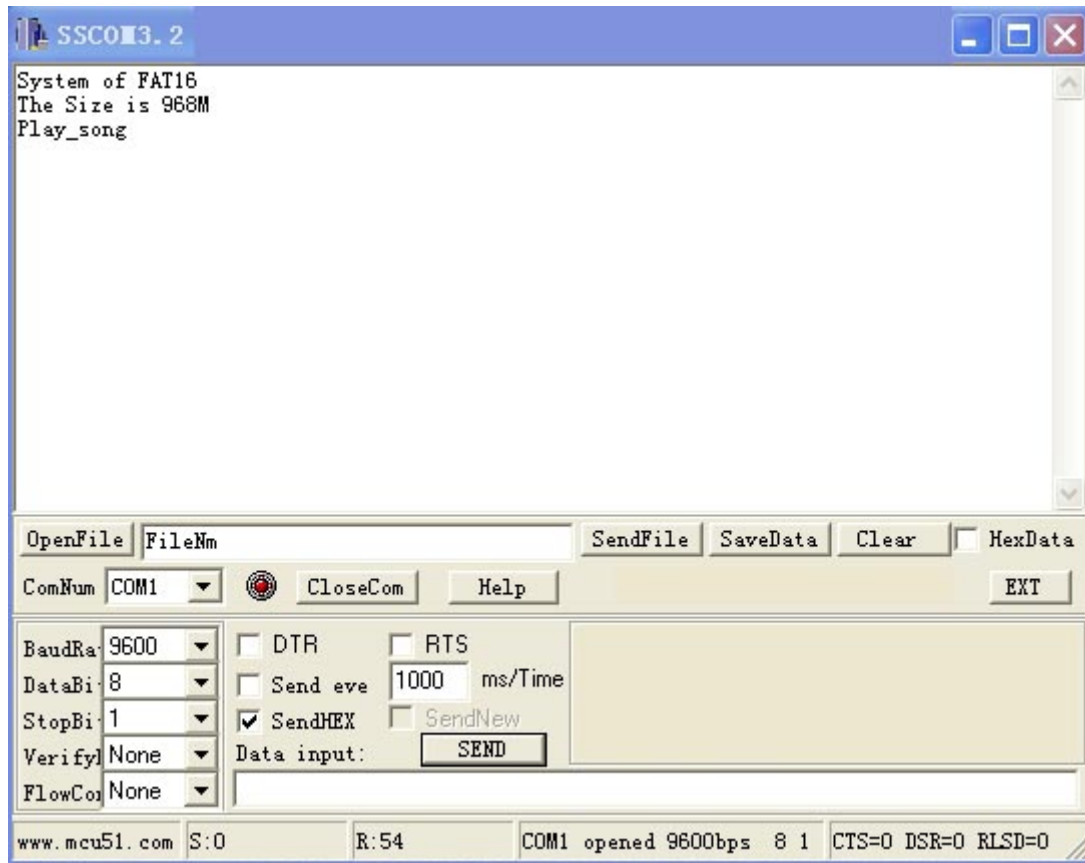

Control Examples

Send : 02 A0 to play song.

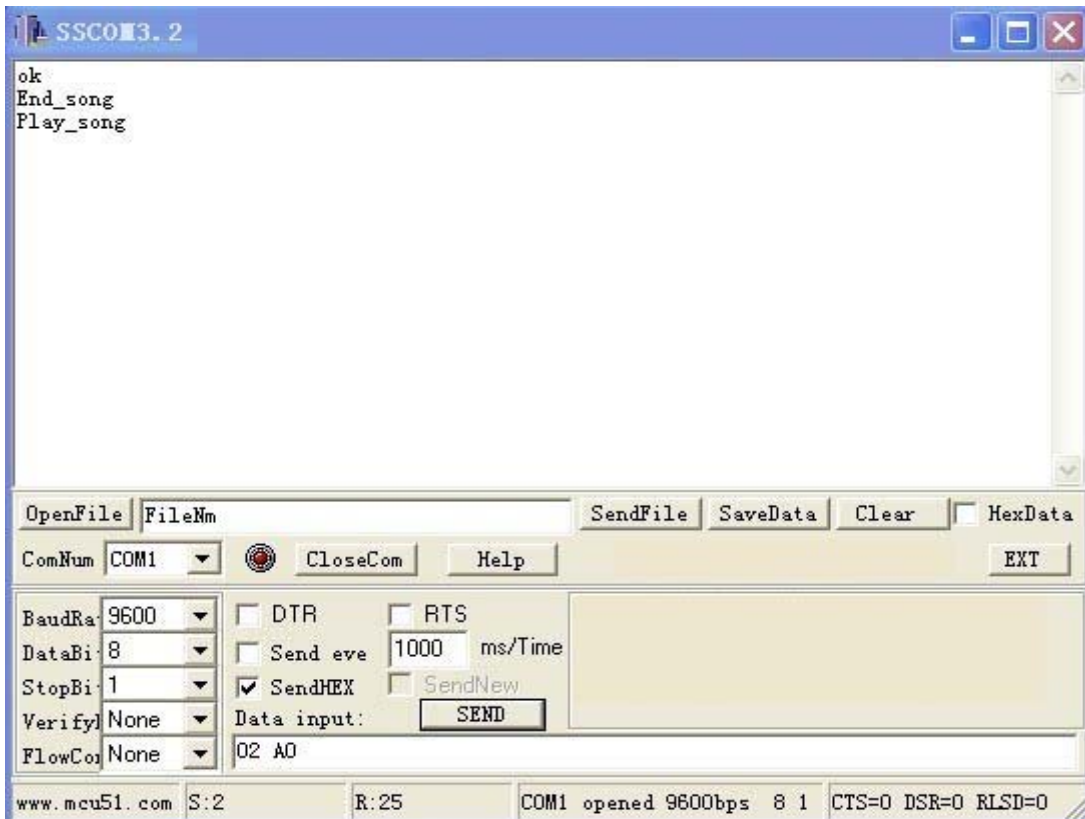

Send : 02 A1 to plause song.

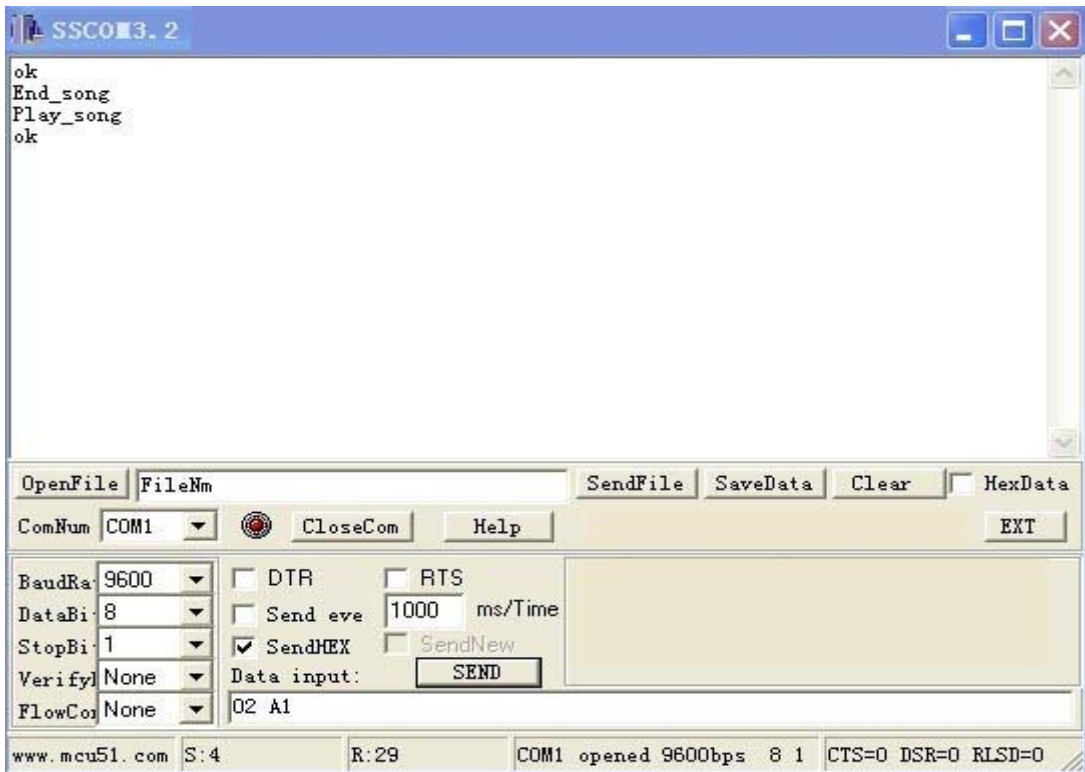

Send : 02 A2 to stop song.

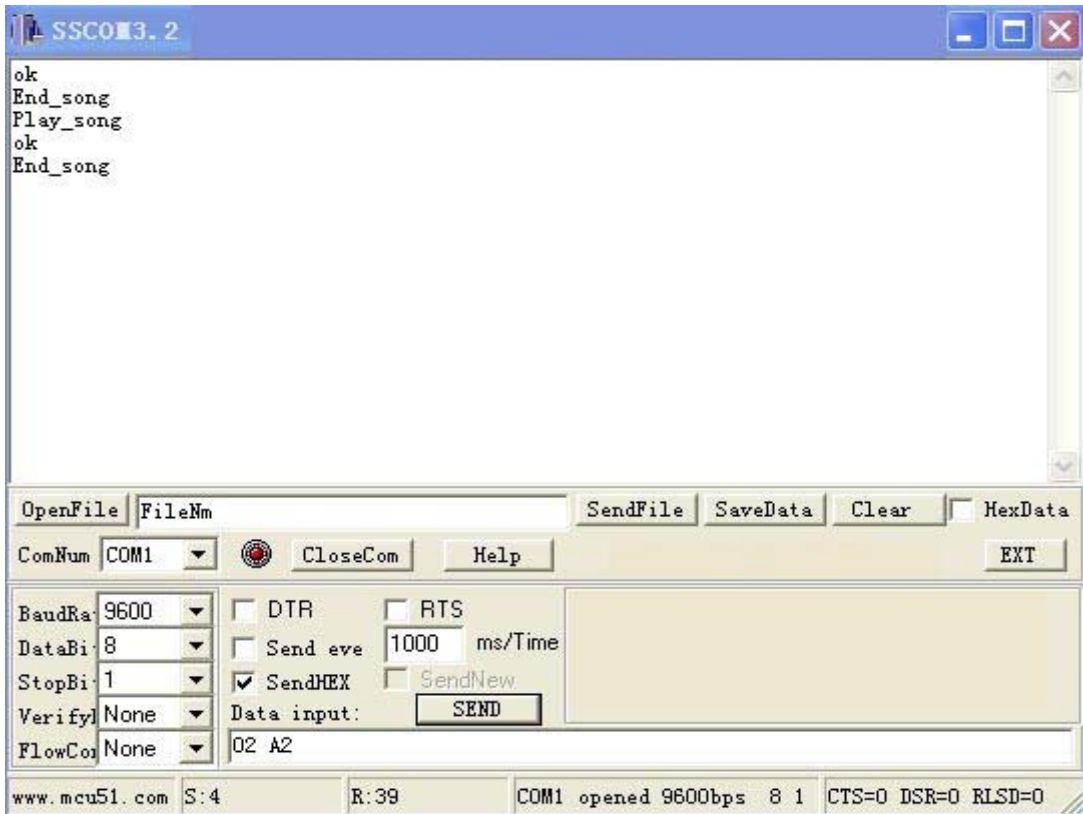

Send : 02 A3 to Play Next song.

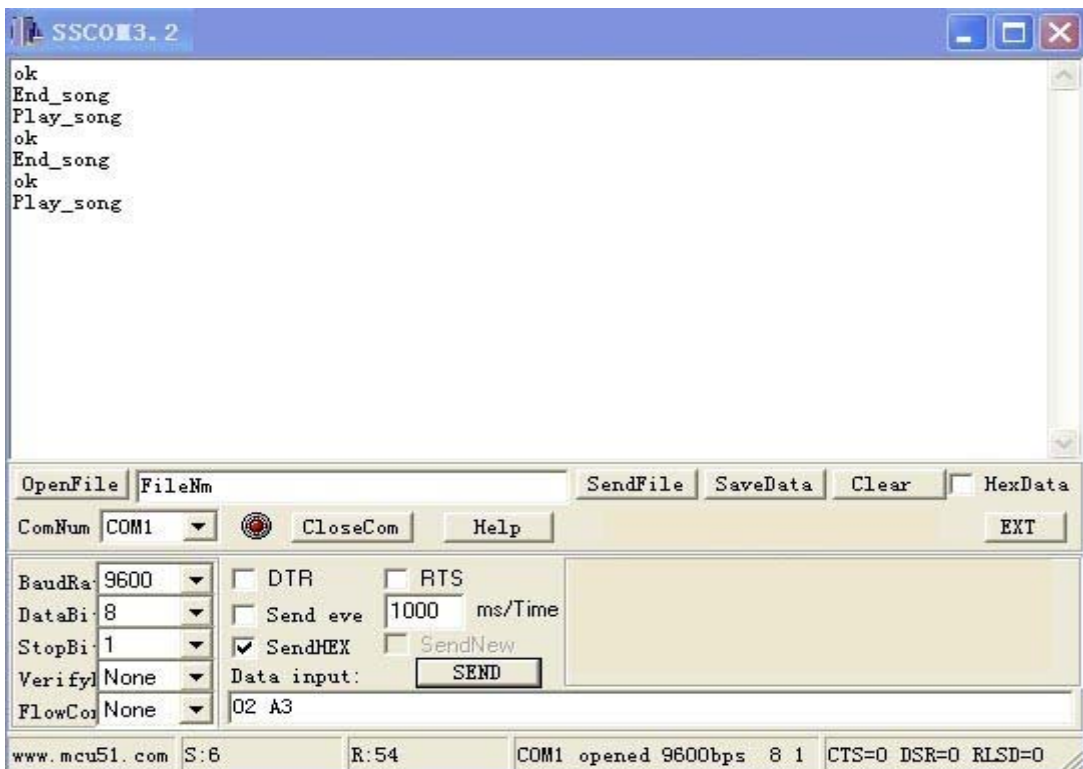

Send : 02 A4 to Play Previous song.

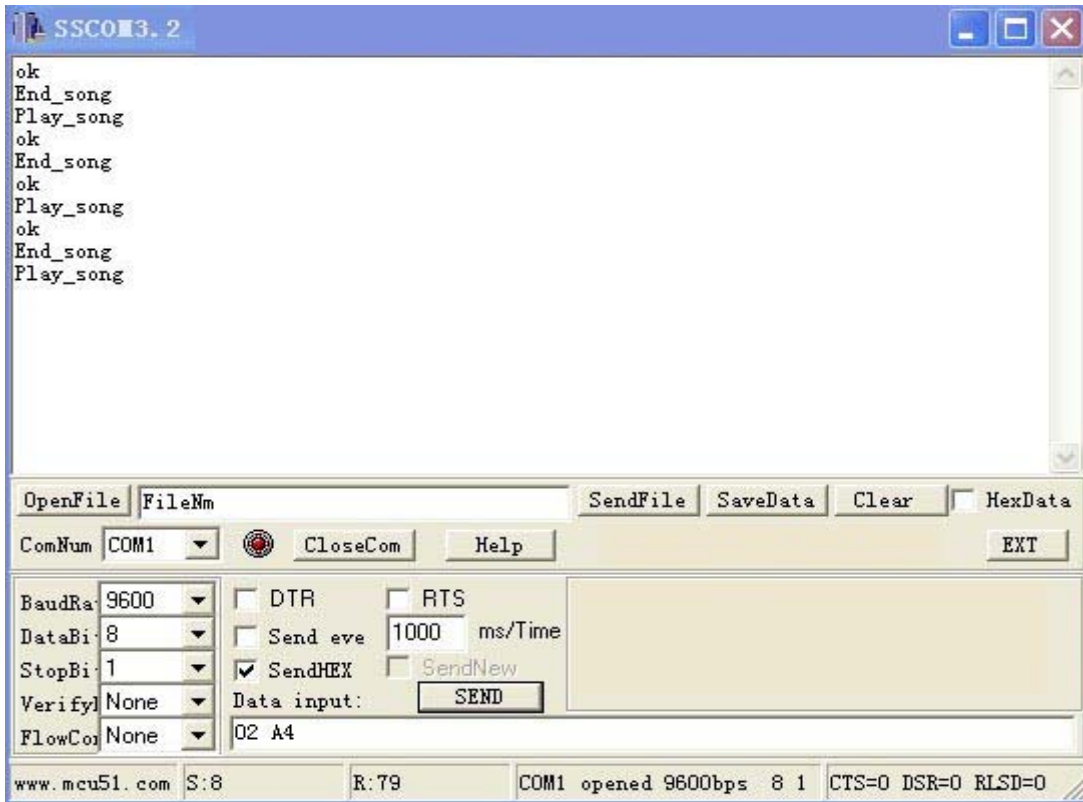

Send: 03 A5 00 for minimum volume (mute)

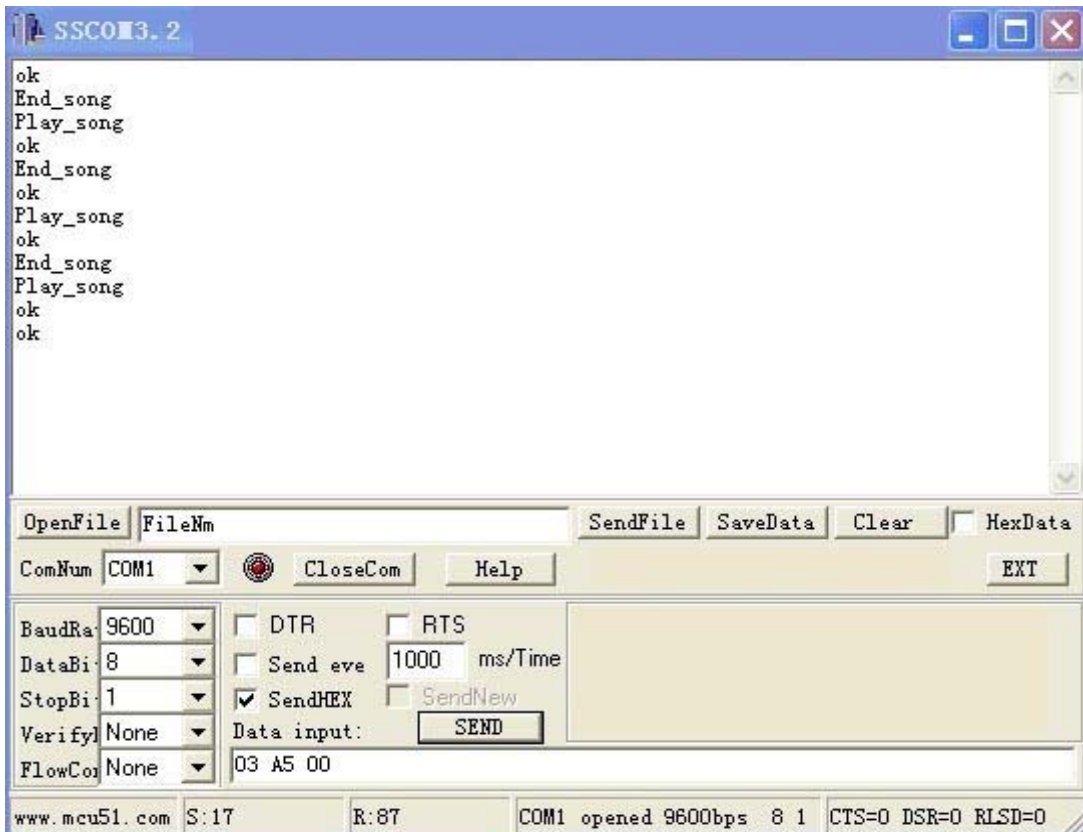

Send: 03 A5 00 for maximum volume , volume can be adjustable from 00 ,01,02,.....08 for SONG or ADVERT

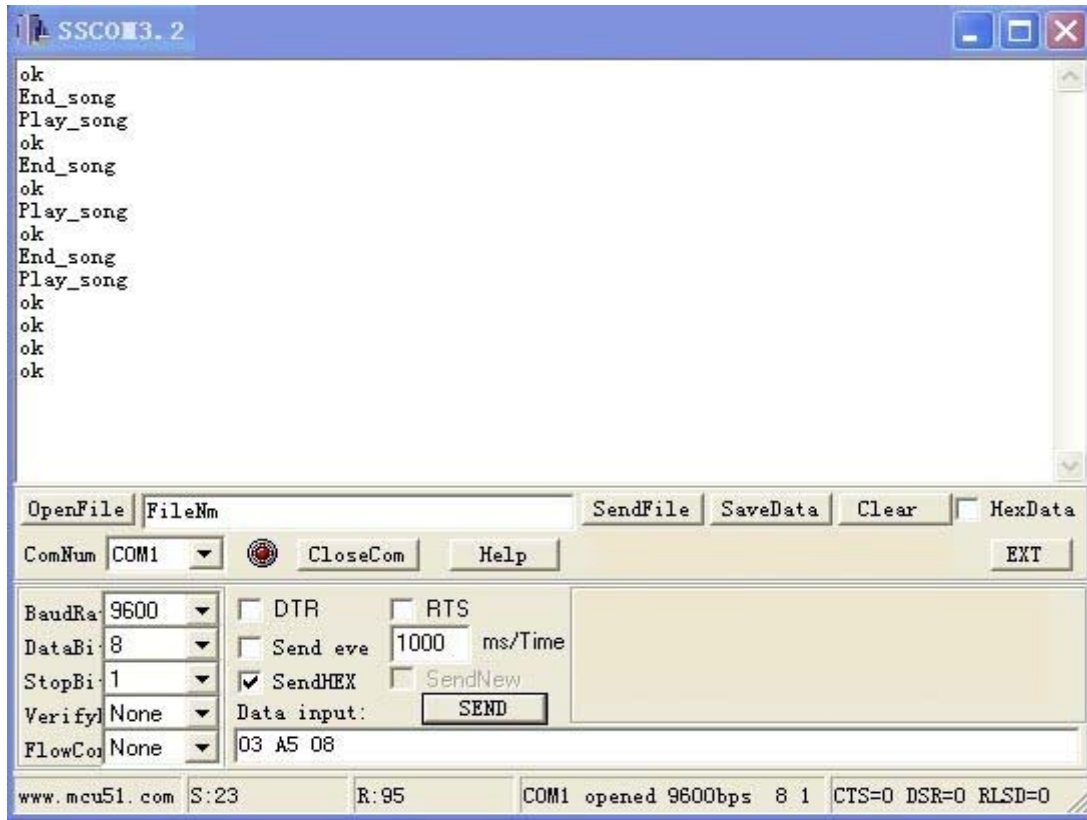

Send :07 A6 30 31 30 30 31 to play ad. (001.mp3 in ADVERT01)

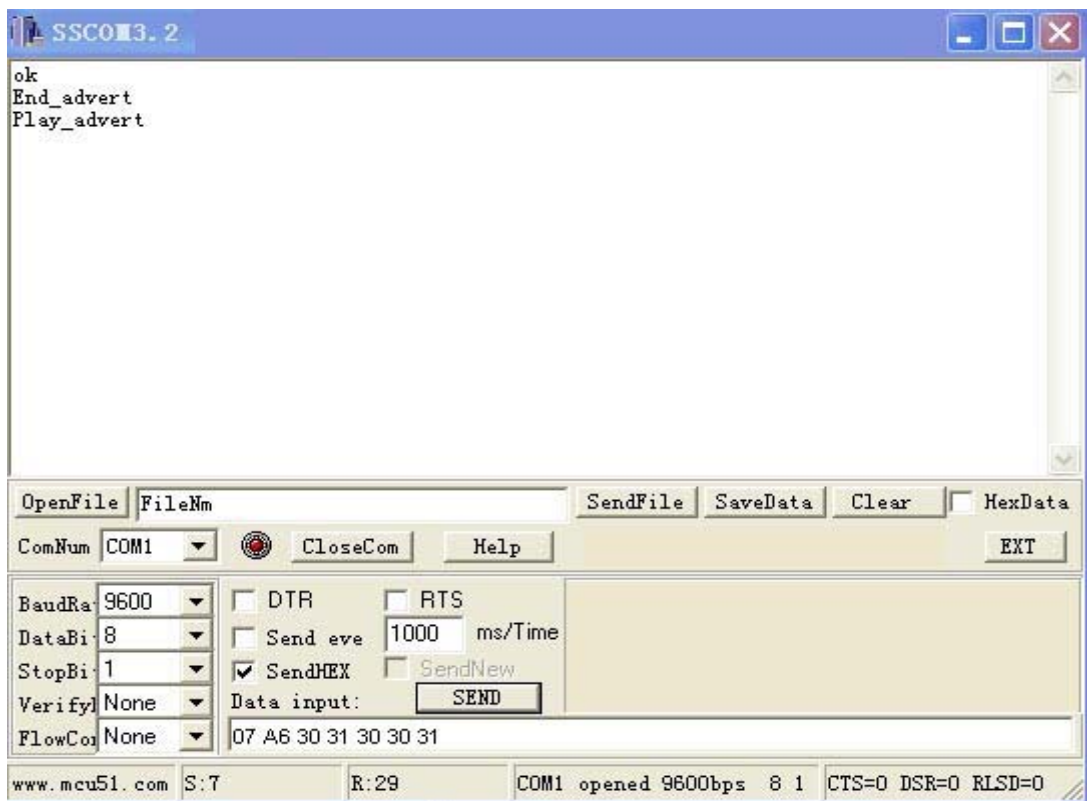

Send :07 A6 30 31 30 30 32 to play ad. (002.mp3 in ADVERT01)

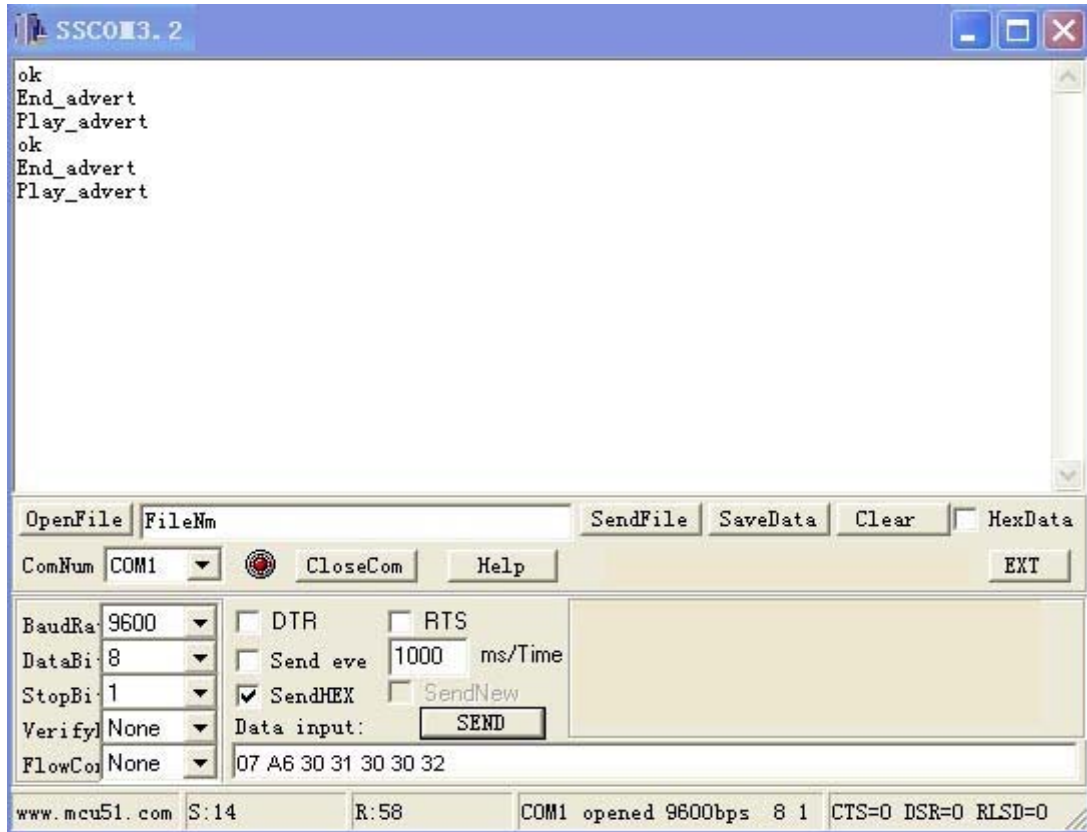

Send :07 A6 30 31 30 30 36 to play ad. (006.mp3 in ADVERT01)

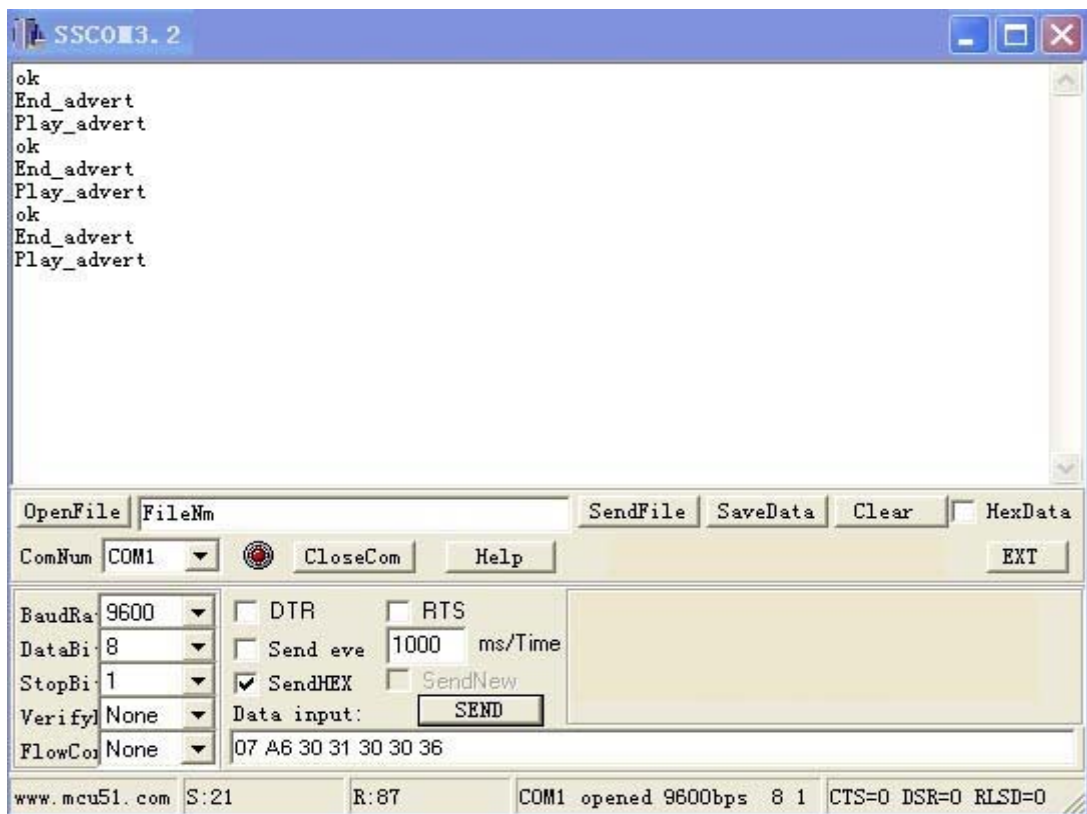

Send :07 A6 30 32 30 30 31 to play ad. (001.mp3 in ADVERT02)

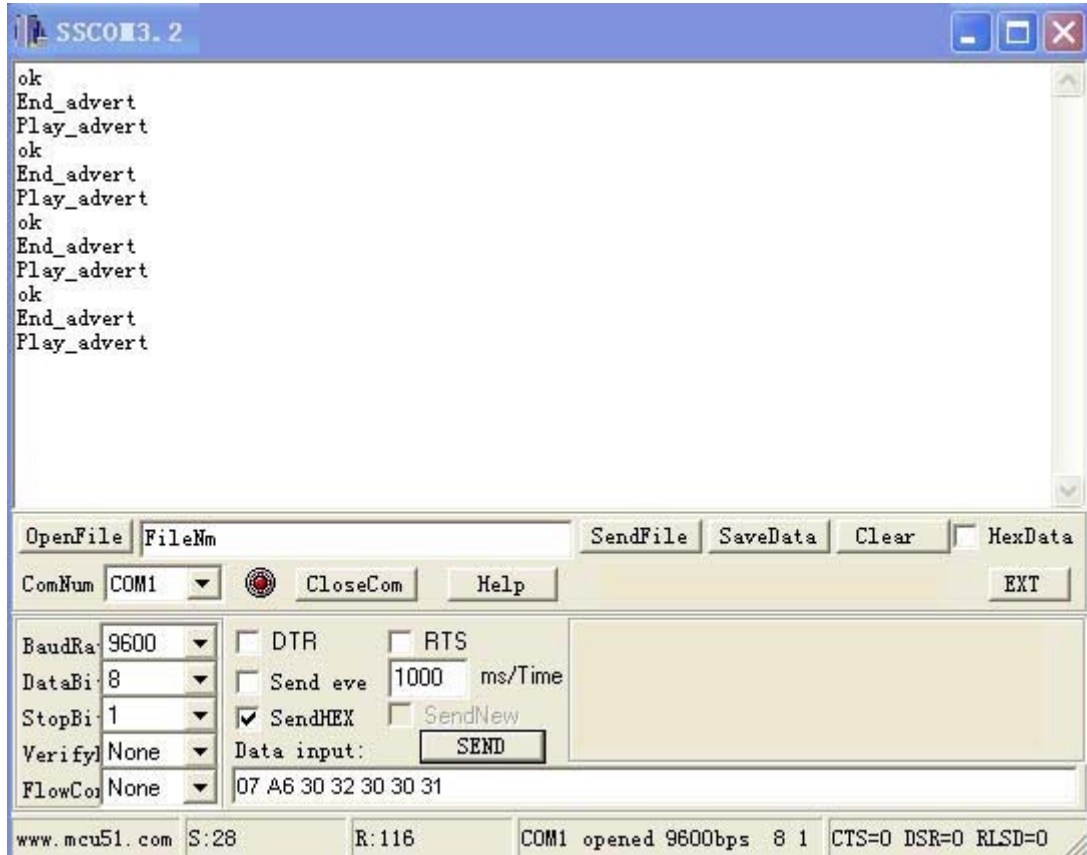

Send :07 A6 30 32 30 30 32 to play ad. (002.mp3 in ADVERT02)

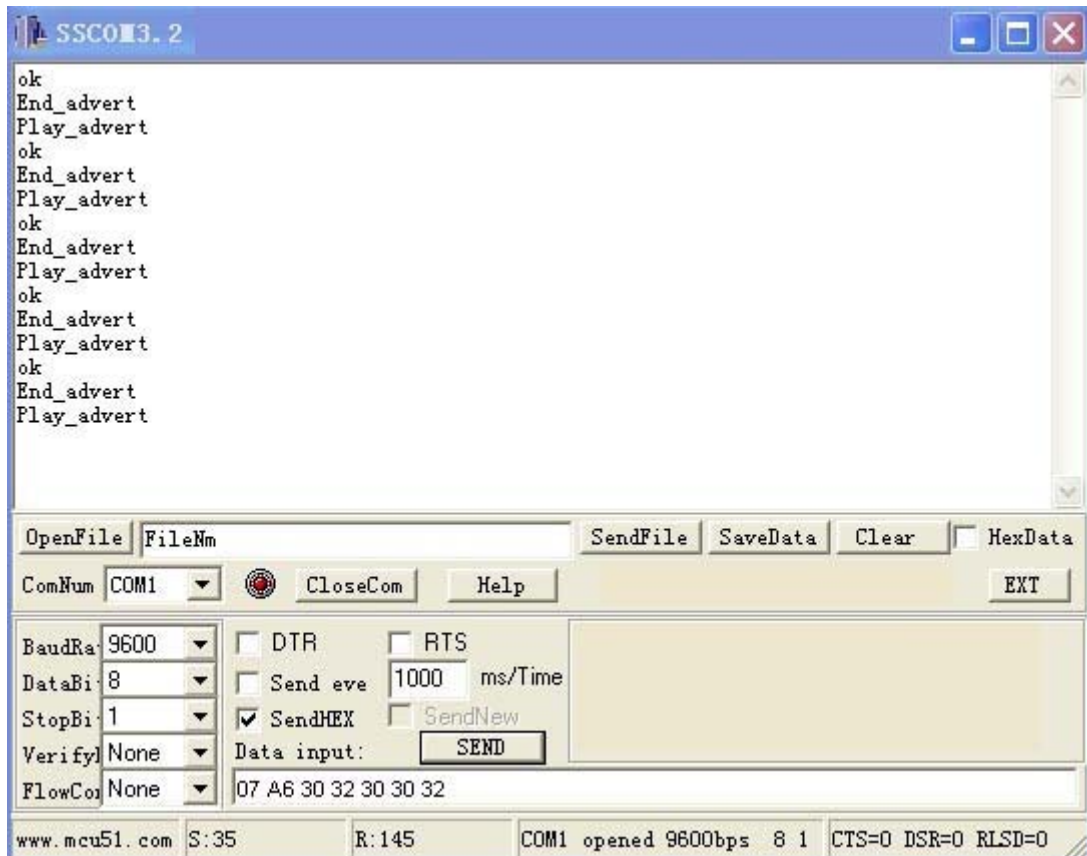

Send :07 A6 30 32 30 30 33 to play ad. (003.mp3 in ADVERT02)

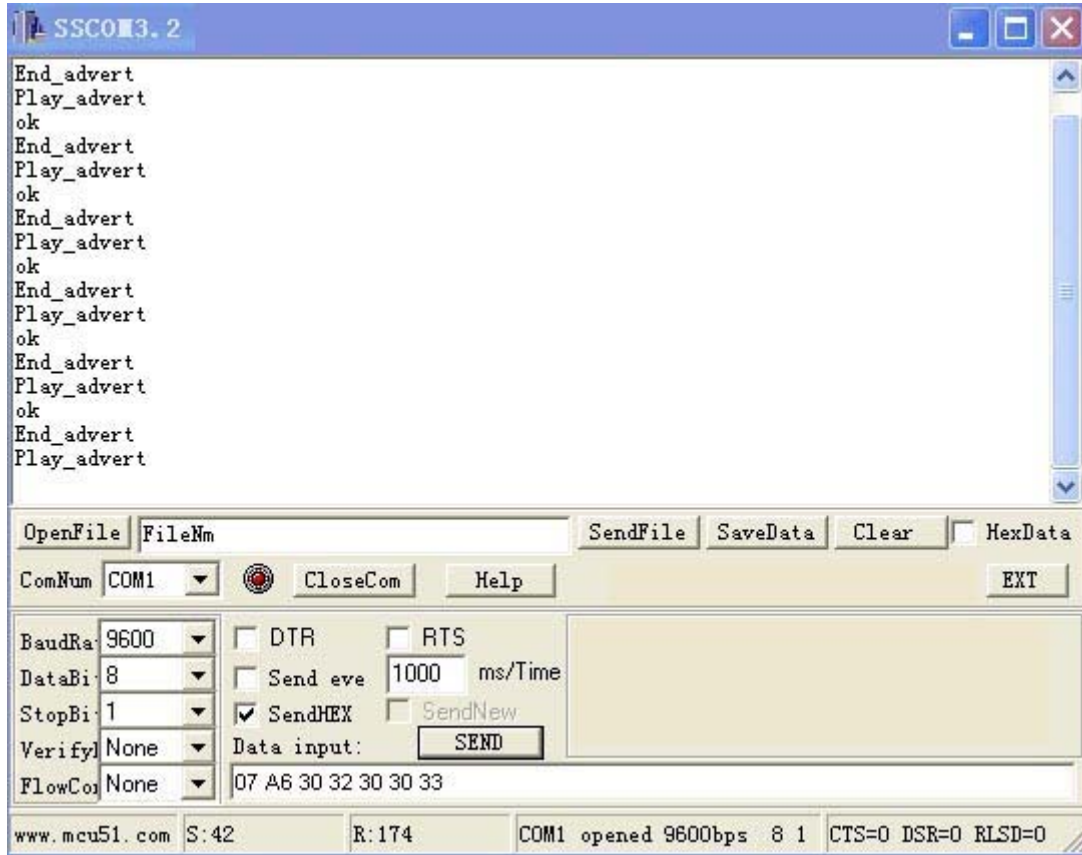

Send :02 A7 to pause ad.

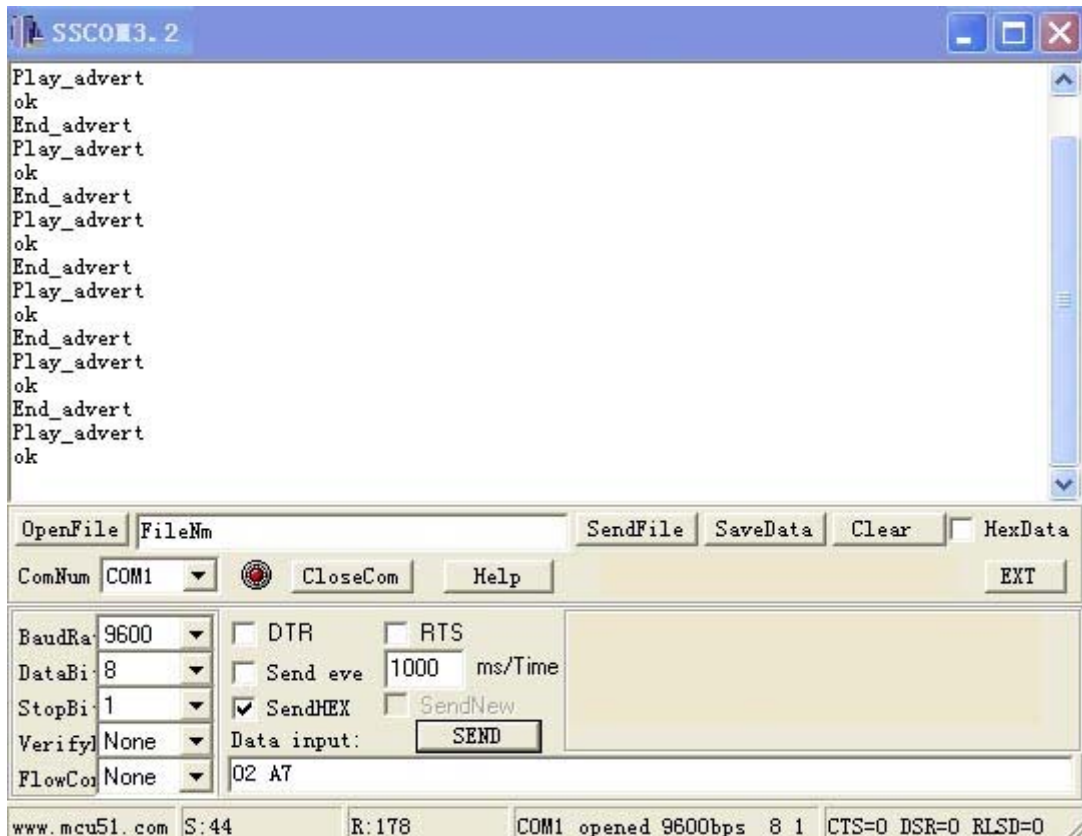

Send :02 A8 to continue ad.

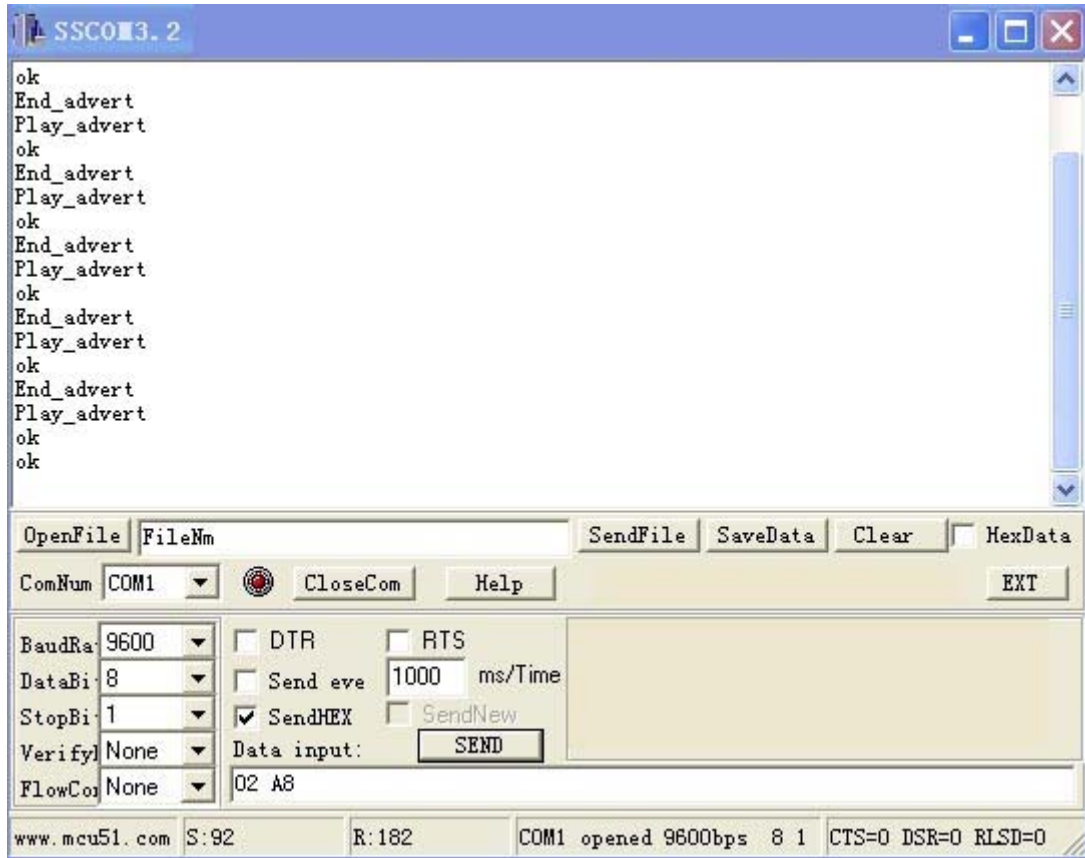

Send :02 A9 to stop ad.

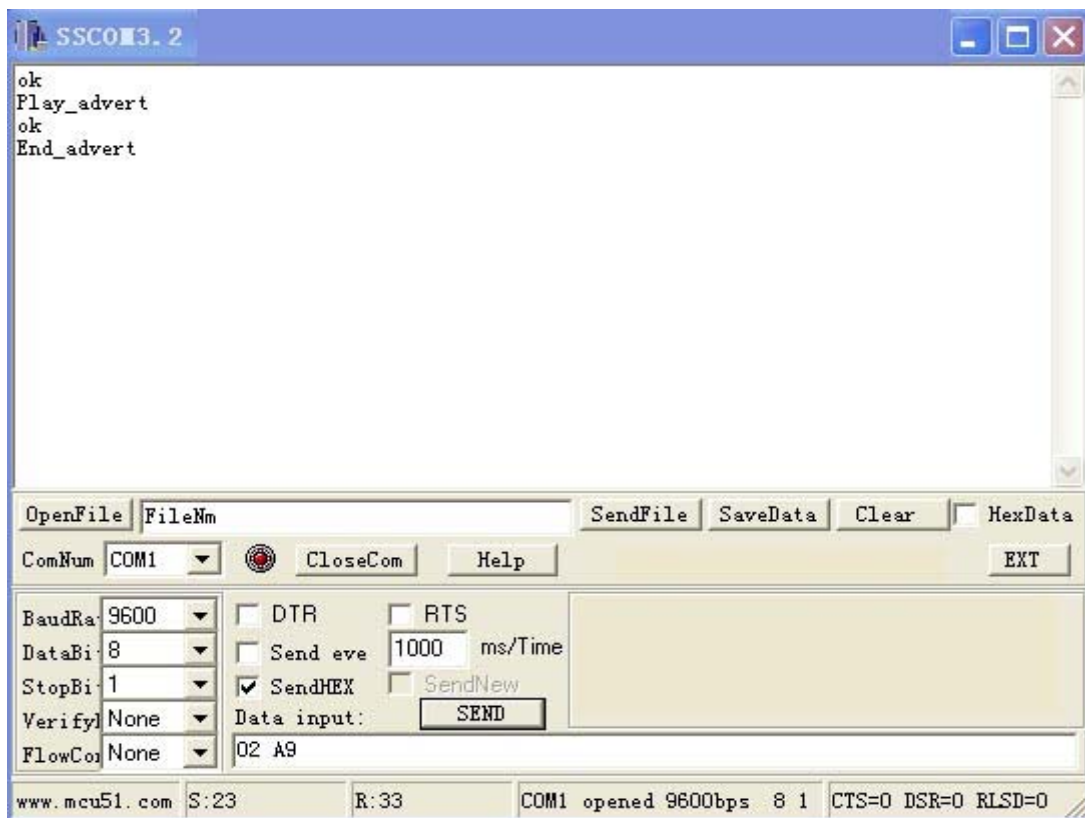

V. Versions

Date	Version	Description
25 th Jan.,2007	V1.0	Chinese Original version
14 th Jun.,2008	V1.1	English version
1 st Oct.,2009	V1.2	English Revised version
1 st April,2010	V1.3	Support up to 2Gb memory card , and FAT32

VI.Contact information**Tenda Electronics Limited**

Add: No.15 Street,Guang Cong North Road,Taiping Economic and Technological

Development Zone,Guangzhou,China

Contact Person : Mr Keith / Miss Lynn / Miss Lisa

Tel: 86-20-22100510 Fax:86-20-37921106

Email:tendaelectronic@gmail.com web:www.tendaelectronics.com
